

Integrated Solution for Position Detection

1 Product Description

The MT5301 supports 3-wire applications for all kinds of position detection sensor.

The MT5301 is an IC which can process all kinds of position sensor signals. It integrates LDO, signal processing module, driver and protection module.

The MT5301 implement protection features for over-current, reversed-voltage & over-temperature conditions.

The MT5301 provides MT5301DT-NPN & MT5301DT-PNP which fix the output mode internally. MT5301DT-NPN corresponding to the low side driver, and MT5301DT-PNP corresponding to the high side driver.

The MT5301 provides DFN2*3-8L for surface mount (MSL1), RoHS compliant.

2 Features

- 8~36V Operating Vcc Range
- Operating Frequency: 20KHz
- -40V Reversed Power Supply Protection
- -40V Reversed Output Protection
- Output Over-Current Protection ($\pm 350\text{mA}$)
- Short Circuit Protection
- Integrated LDO up to 40mA Current
- $-40^{\circ}\text{C}\sim 105^{\circ}\text{C}$ Operating Temperature
- Package Option: DFN2*3-8L
- RoHS Compliant: (EU)2015/863

3 Product Overview of MT5301

Part No.	Description
MT5301DT-NPN	DFN2*3-8L, tape & reel (3000pcs/bag)
MT5301DT-PNP	DFN2*3-8L, tape & reel (3000pcs/bag)

Remark:

The marking of MT5301DT-NPN is 5301N

The marking of MT5301DT-PNP is 5301P

4 Applications

- Coil Position Sensor
- Photoelectric Position Sensor

5. Pin Configuration and Functions

No.	Name	Description
1	VCC	Power Supply
2	V _{LDO}	LDO Output
3	VN	Input-
4	OUT	Output
5	GND	Ground
6	LED	LED Output
7	SEL	Threshold Selection
8	VP	Input+

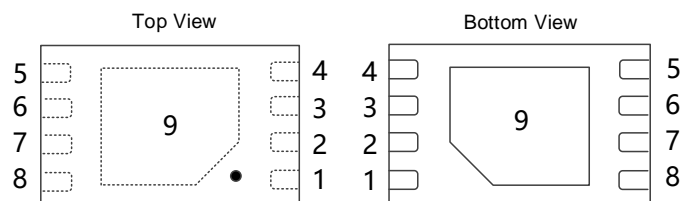

Figure.1 Pin Configuration & Functions

Table of Contents

1	Product Description.....	1
2	Features.....	1
3	Product Overview of MT5301	1
4	Applications.....	1
5	Pin Configuration and Functions.....	1
6	Functional Block Diagram	3
7	Electrical and Magnetic Characteristics.....	3
	7.1 Absolute Maximum Ratings.....	3
	7.2 ESD Ratings.....	3
	7.3 Electrical Specifications.....	4
	7.4 EMC Specifications.....	5
	7.5 Characteristic Performance.....	6
8	Overcurrent Protection Description.....	8
9	Package Information.....	9

6 Functional Block Diagram

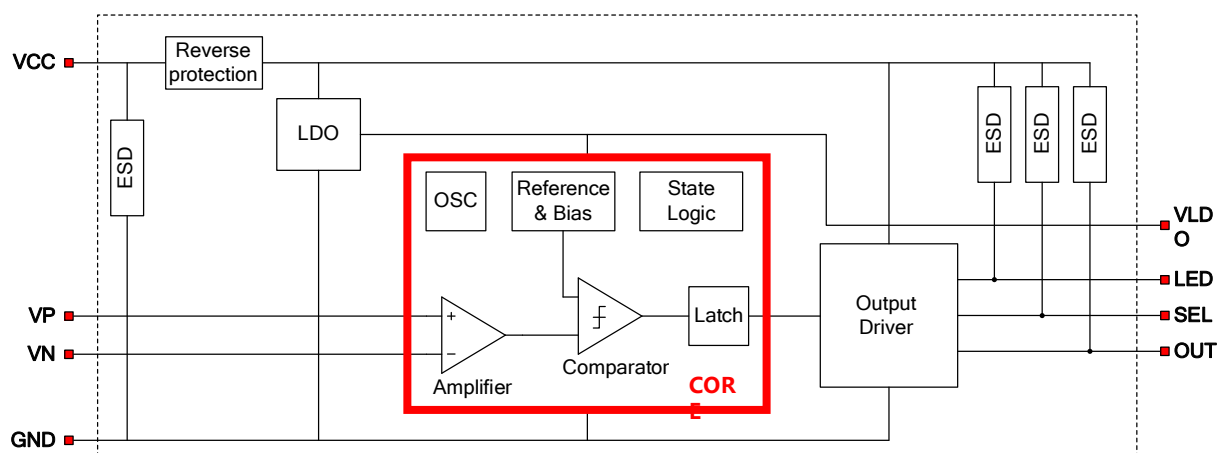

Figure.2 Functional Block Diagram

7 Electrical and Magnetic Characteristics

7.1 Absolute Maximum Ratings

Absolute maximum ratings are limited values to be applied individually, and beyond which the serviceability of the circuit may be impaired. Functional operability is not necessarily implied. Exposure to absolute maximum rating conditions for an extended period of time may affect device reliability. All voltages listed are referenced to GND.

Symbol	Parameters	Min	Max	Units
V _{CC}	Supply Voltage	-40	40	V
V _{OUT}	Output Voltage	-40	40	V
I _{OUT}	Continuous Output Current	-500	500	mA
V _{IN}	VN & VP	-0.7	5.5	V
V _{LED}	LED Output Voltage	-0.7	5.5	V
V _{LDO}	LDO Voltage	-0.7	5.5	V
V _{SEL}	SEL Voltage	-0.7	5.5	V
I _{LDO}	LDO Output Current	-	50	mA
T _A	Operating Ambient Temperature	-40	105	°C
T _S	Storage Temperature	-50	150	°C

7.2 ESD Ratings

Symbol	Reference	Values	Unit	
V _{ESD}	Human-body model (HBM)	AEC-Q100-002	4000	V
	Charged-device model (CDM)	AEC-Q100-011	1000	V

7.3 Electrical Specifications

At $T_A = -40 \sim 105 \text{ }^\circ\text{C}$, $V_{CC} = 8\text{V} \sim 36\text{V}$, $C_{LDO} = 1\mu\text{F}$ (unless otherwise specified)

Symbol	Parameters	Test Condition	Min	Typ	Max	Unit
V_{CC}	Supply Voltage		8	-	36	V
I_{IN}	VN & VP Input Current	$-0.7\text{V} \leq V_P \ \& \ V_N < V_{CC} + 0.5\text{V}$	-	-	0.01	mA
		$V_{CC} + 0.5\text{V} \leq V_P \ \& \ V_N \leq 5.5\text{V}$	-	-	2	mA
I_{CC}	Supply Current	$V_{CC} = 24\text{V}; V_P - V_N < V_{DIF(OFF)}$	-	220	500	uA
V_{SAT}	Output Saturation Voltage	$V_{CC} = 24\text{V}; I_{OUT} = 200\text{mA}; V_P - V_N > V_{DIF(ON)};$ Pull-up Loading	-	-	0.8	V
		$V_{CC} = 24\text{V}; I_{OUT} = -200\text{mA}; V_P - V_N > V_{DIF(ON)};$ Pull-down Loading	$V_{CC} - 0.8$	-	-	
I_{OCP}	Output Over-current Protection Limit	$ B > B_{OP} ;$ Pull-up Load		350		mA
		$ B > B_{OP} ;$ Pull-down Load		350		
I_{HOLD}	Holding Current	$ B > B_{OP} ;$ Pull-up Load		300		mA
		$ B > B_{OP} ;$ Pull-down Load		300		
I_{RLS}	Release Current	$ B > B_{OP} ;$ Pull-up Load		230		mA
		$ B > B_{OP} ;$ Pull-down Load		230		
t_{dOUT}	Over-current cut off delay time			4		mS
t_{ROUT}	Output restart delay time after cut off			110		mS
I_{OFF}	Output Leakage Current	$V_P - V_N < V_{DIF(OFF)}; V_{OUT} = 24\text{V};$ Pull-up Loading	-	-	10	uA
		$V_P - V_N < V_{DIF(OFF)}; V_{CC} = 24\text{V};$ Pull-down Loading	-10	-	-	
I_{LED}	LED Pin Output Current	$V_P - V_N > V_{DIF(ON)}$	-	-0.7	-	mA
F_{SW}	Switching Frequency	$V_{CC} = 24\text{V}$	-	20	-	KHz
T_R	Output Rise Time	$V_{CC} = 24\text{V};$ Pull-down Loading	-	-	30	us
T_F	Output Fall Time	$V_{CC} = 24\text{V};$ Pull-up Loading	-	-	30	us
T_{OTPR}	Over Temperature Protection Point	Junction Temperature	-	140	-	$^\circ\text{C}$
T_{OTRC}	Over Temperature Recovery Point	Junction Temperature	-	130	-	$^\circ\text{C}$

Symbol	Parameters	Test Condition	Min	Typ	Max	Unit
V _{DIF1(ON)}	Differential Input Voltage (on)	VP-VN>V _{DIF(ON)} , I _{LED} & Output On, SEL Floating	600	670	740	mV
V _{DIF1(OFF)}	Differential Input Voltage (off)	VP-VN<V _{DIF(OFF)} , I _{LED} & Output Off, SEL Floating	450	520	590	mV
V _{DIF2(ON)}	Differential Input Voltage (on)	VP-VN>V _{DIF(ON)} , I _{LED} & Output On, SEL=Low	150	250	350	mV
V _{DIF2(OFF)}	Differential Input Voltage (off)	VP-VN<V _{DIF(OFF)} , I _{LED} & Output Off, SEL=Low	100	200	300	mV
V _{LDO}	LDO Output Voltage	8V≤V _{CC} ≤36V, I _{LOAD} =1mA	4.95	5	5.05	V
I _{LDO_Limit}	LDO Short Circuit Current Limit	V _{LDO} Shorted to GND		80		mA
ΔV _{LINE}	V _{LDO} Line Regulation	8V≤V _{CC} ≤36V, I _{LOAD} =1mA, T _A =25 °C		10		mV
ΔV _{LOAD}	V _{LDO} Load Regulation	V _{CC} =24V, 0≤I _{LOAD} ≤40mA		40		mV
V _{noise}	LDO Output Noise Voltage	V _{CC} =24V, I _{LOAD} =1mA, full bandwidth, T _A =25 °C		300		μV _{RMS}
PSRR	LDO Power Supply Rejection Ratio	V _{CC} =24V, I _{LOAD} =1mA, f=100Hz		50		dB

7.4 EMC Specifications

At T_A=-40~105 °C, V_{CC}=8V~36V (unless otherwise specified)

Symbol	Test Condition	Typ	Unit
EFT	IEC 61000-4-4	±4000	V
V Surge	IEC 61000-4-5	±100	V

7.5 Characteristic Performance

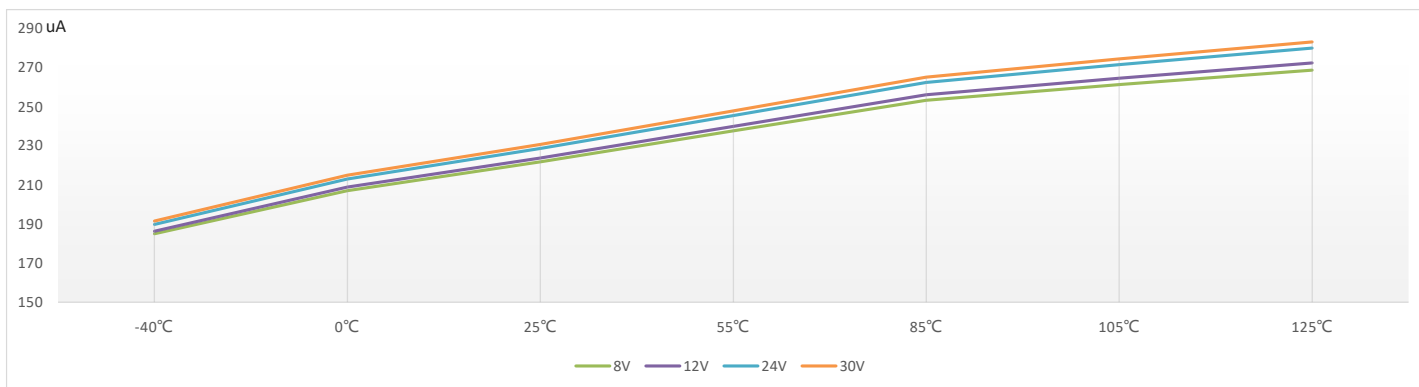

Figure.6 Supply Current vs . Temperature & Vcc

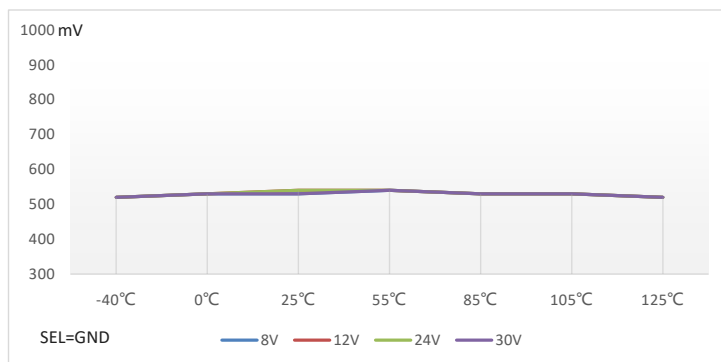
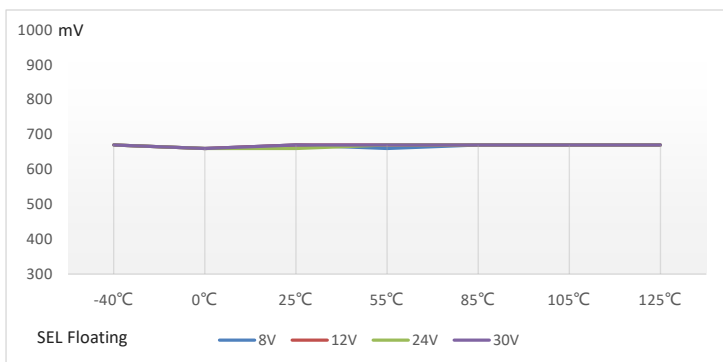

Figure.8 Magnetic Characteristics vs. Temperature & Vcc (Vdiff on)

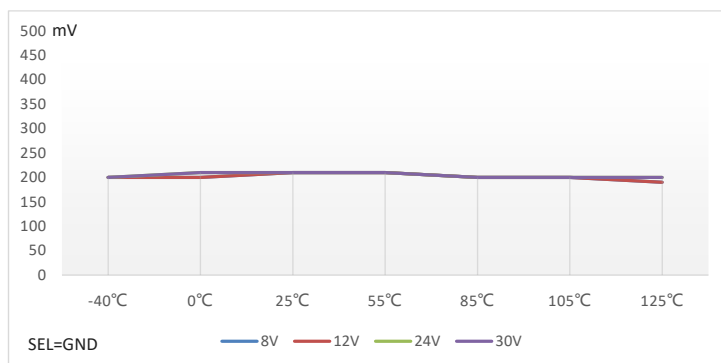
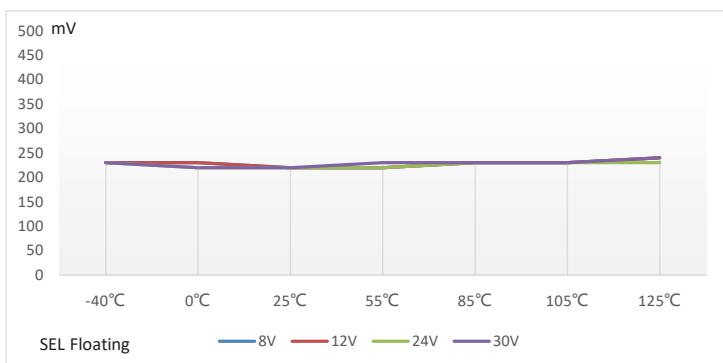

Figure.9 Magnetic Characteristics vs. Temperature & Vcc (Vdiff off)

7.5 Characteristic Performance

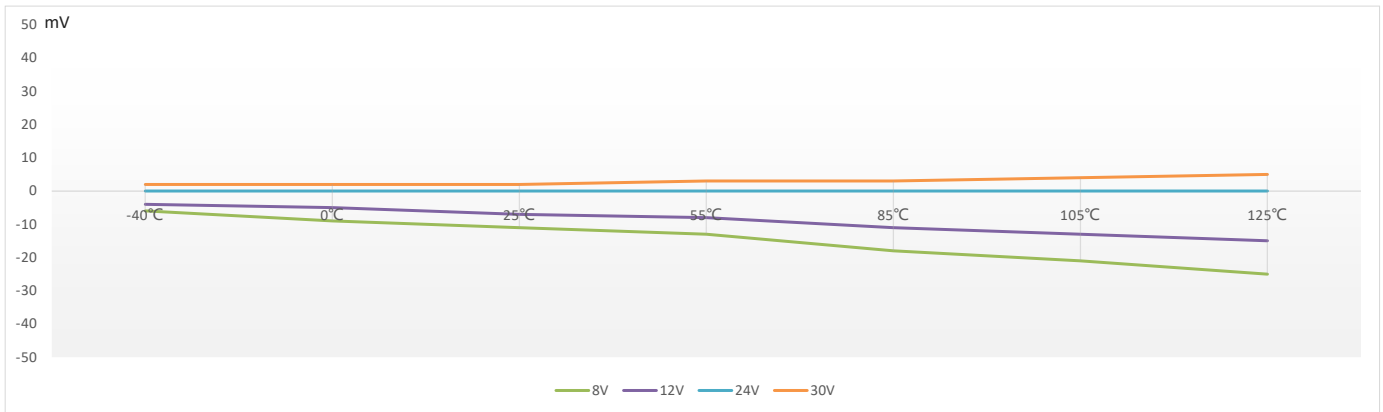

Figure.10 Line Regulation of LDO vs. Temperature (Compared to 24V)

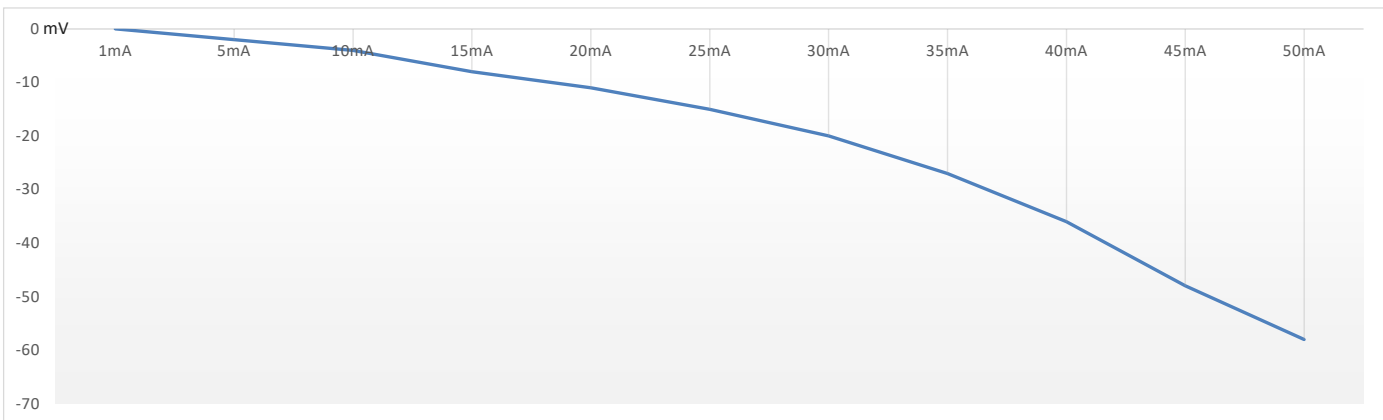

Figure.11 Load Regulation of LDO (Vcc=24V)

Note: The load regulation is highly sensitive to the thermal budget of the PCB design

8 Overcurrent Protection Description

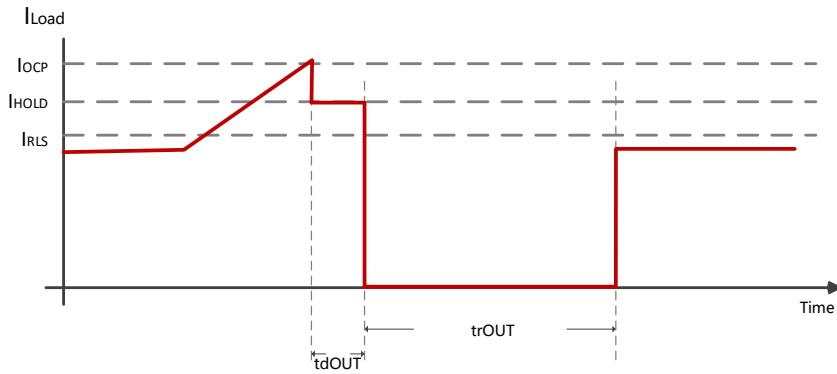

Figure.12 Overcurrent Protection

The overcurrent protection been trigged when output current larger than I_{OCP} , then the chip will clamp the output current at I_{HOLD} and keep t_{dOUT} , the chip will keep monitoring the status of the output current during the t_{dOUT} .

If the output current always larger than I_{RLS} during the t_{dOUT} , the chip will cut the output after t_{dOUT} , and keep t_{rOUT} .

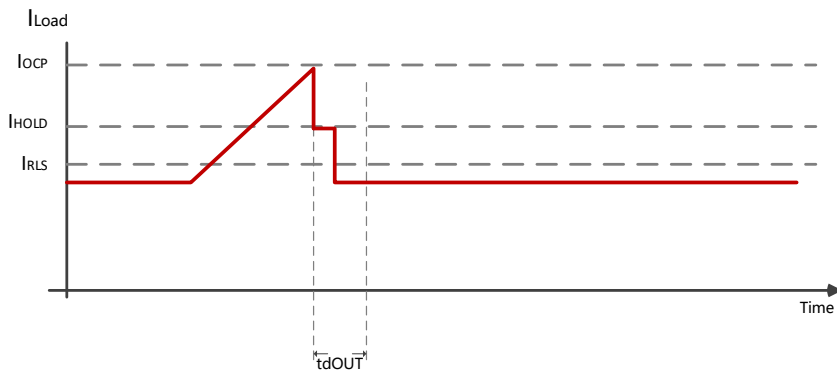

Figure.13 Overcurrent Protection

The chip will detect the status of the output current again after t_{rOUT} , when the output current smaller than I_{RLS} , the chip will release the status of overcurrent protection. Otherwise, the chip will keep the overcurrent protection status until the output current smaller than I_{RLS} .

Figure15 shows the overcurrent phenomenon disappears during the t_{rOUT} .

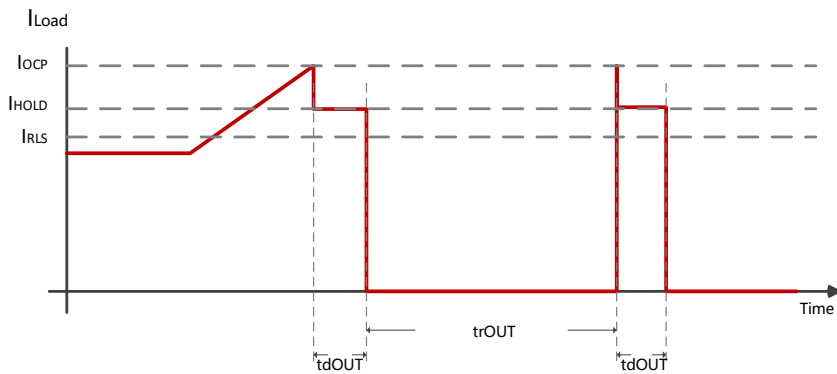

Figure.14 Overcurrent Protection

Figure16 shows the overcurrent phenomenon disappears during the t_{dOUT} .

Figure17 shows the overcurrent phenomenon keep going

9 Package Information (For Reference Only – Not for Tooling Use)

9.1 DFN 2*3 8L Package Information

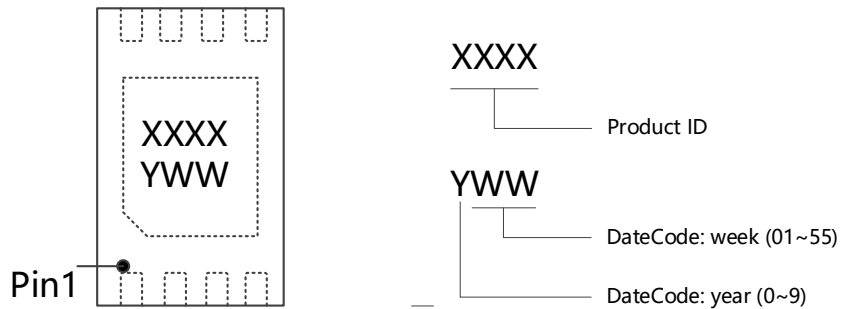

Figure.15 DFN 2*3 8L Chip Marking Spec

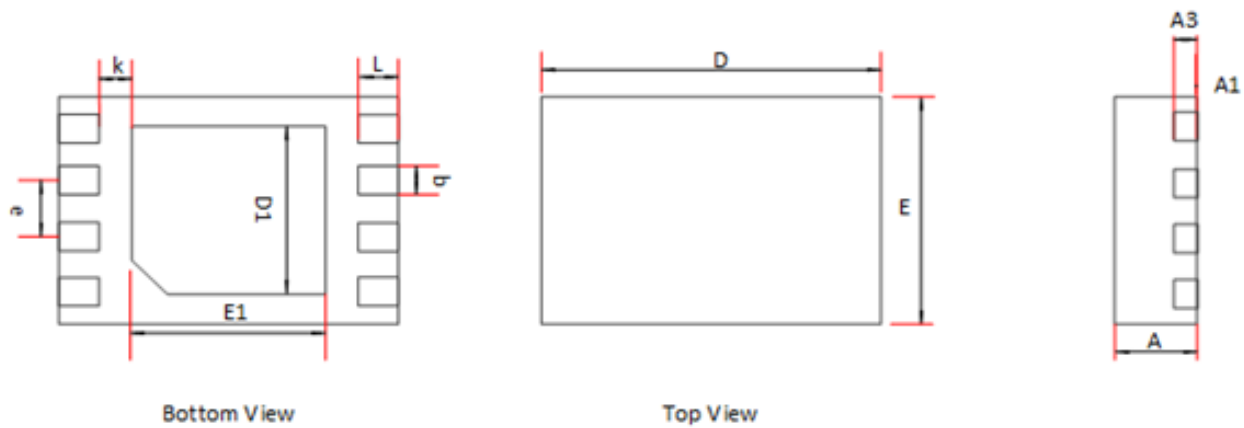

Figure.16 DFN 2*3 8L Package Drawing

Symbol	Dimensions in Millimeters		Dimensions in Inches	
	Min	Max	Min	Max
A	0.700	0.800	0.028	0.031
A1	0.000	0.050	0.000	0.002
A3	0.203 REF		0.008 REF	
D	2.950	3.050	0.116	0.120
E	1.950	2.050	0.077	0.081
D1	1.400	1.600	0.055	0.063
E1	1.600	1.800	0.063	0.071
b	0.200	0.300	0.008	0.012
e	0.500 TYP		0.020 TYP	
k	0.200 MIN		0.008 MIN	
L	0.300	0.400	0.012	0.016